

SUNTECK

INSTALLATION MANUAL



RO BIF BEF- CLASSIC SLIM

ELECTRIC FLAT PANEL FIREPLACE HEATER

Model#: ■ STFP-50BIF ■ STFP-60BIF

OWNER'S MANUAL - CLASSIC SERIES

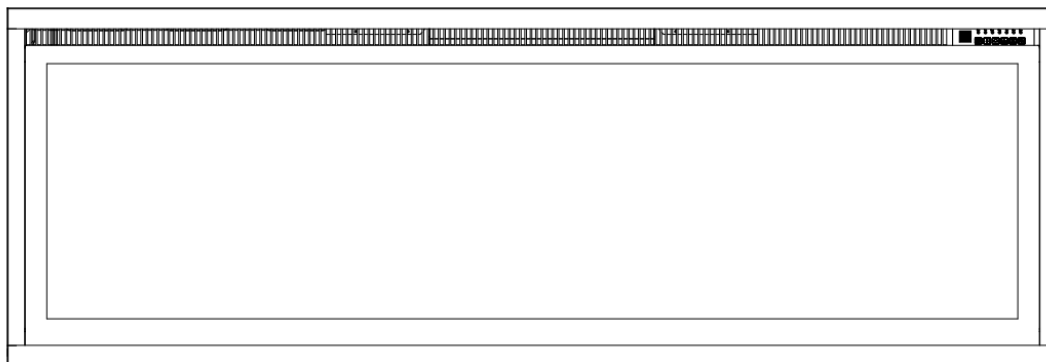

50"/60"/72" Wall Mounted / Built-in Electric Fireplace

AC 110V-120V 60Hz 1500W

! WARNING

Read and understand this entire owner's manual, including **all safety information**, before plugging in or **using** this product. Failure to do so could result in **fire, electric shock, or serious personal injury**.

! CAUTION

Keep this owner's manual for future reference. If you sell or give this product away, **make sure this manual accompanies this product**

SUNTECK



www.sunteck.ca

info@sunteck.ca

IMPORTANT SAFETY INFORMATION!

WARNING

When using electrical appliances basic precautions should always be followed to reduce the risk of fire, electric shock and injury to persons, including the following:

- Read all instructions before using this heater
- This heater is hot when in use. To avoid burning, do not touch hot surface. If provided, use handles when moving this heater. Keep combustible materials, such as furniture, pillows, bedding, papers, clothes, and curtains at least 1 m from the front of the heater and keep them away from the sides and rear. In order to avoid overheating, do not cover the heater.
- Extreme caution is necessary when any heater is used near children or the infirm and whenever the heater is left operating and unattended.
- Always unplug heater when not in use.
- Do not operate any heater with a damaged cord or plug or after the heater malfunctions, has been dropped damaged in any manner, return heater to authorized service facility for examination, electrical or mechanical adjustment, or repair.
- Indoor use only, do not use outdoors.
- This heater is not intended for use in bathrooms, laundry areas and similar indoor locations. Never locate heater where it may fall into a bathtub or other water container.
- Do not run cord under carpeting. Do not cover cord with throw rugs, runners, or similar coverings. Arrange cord away from traffic area and where it will not be tipped over.
- To disconnect heater, turn controls to off, then remove plug from outlet.
- Do not inset or allow foreign objects to enter any ventilation or exhaust opening as this may cause an electric shock or fire, or damage the heater.
- To prevent a possible fire, do not block air intakes or exhaust in any manner. Do not use on soft surfaces, like a bed, where openings may become blocked.
- A heater has hot and arcing or sparking parts inside. Do not use it in areas where gasoline, or flammable liquids are used or stored.
- Use this heater only as describes in this manual. Any other use not recommended by the manufacturer may cause fire, electric shock, or injury to persons.
- DANGER-HIGH Temperatures may be generated under certain abnormal conditions. Do not partially or fully cover or obstruct the front of this heater.
- Replacement of the lamps should be done only while the heater is disconnected from the supply circuit
- This appliance is not intended for use by persons (including children) with reduced physical, sensory or capabilities, or lack of experience and knowledge, unless they have been given supervision or instruction concerning use of the appliance by a person responsible for their safety. Children should be supervised to ensure that they do not play with the appliance.
- CAUTION: In order to avoid a hazard due to inadvertent resetting of the thermal cut-out, this appliance must not be supplied through an external switching device, such as a timer, or connected to a circuit that is regularly switched on and off by the utility.

Preparation











This product includes a **GLASS panel!** Always use **extreme caution** when handling **glass**. Failure to do so could result in **personal injury** or **property damage**

Remove all parts and hardware from the carton and place them on a clean, soft, dry surface. Parts and assembly steps are grouped for wall-hanging or recessing use. Check the parts list to make sure nothing is missing. Dispose of packaging materials properly. Please recycle whenever possible.

You will need the following tools (not included): Phillips screwdriver; stud finder; level; tape measure; electric drill; 1/4" wood drill bit, hammer.

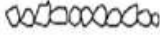
Parts and Hardware

 <p>A – Fireplace</p>			
	<p>B – Wood Screws</p>		<p>C – Drywall anchors</p>
	 <p>Remote Control</p>		
 <p>E-Wall Bracket Fixed on back of firebox</p>	 <p>F-Decorative Crystals</p>	 <p>G-Decorative Pebbles</p>	 <p>H - Drift Logs</p>

Specification and Dimension

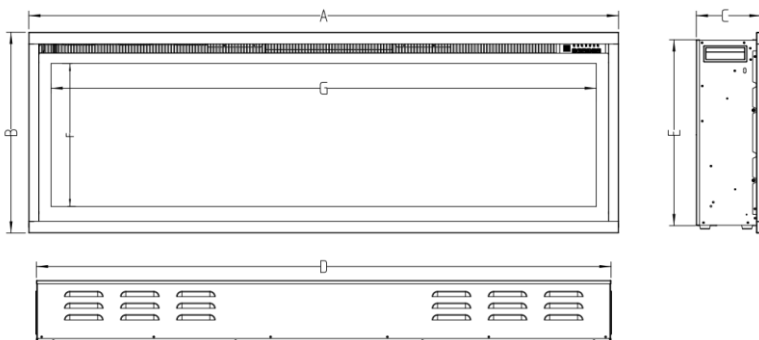

Description	Electric Fireplace
Type	3 Way Mounting Unit Wall-Mount, Recess into Wall and Assemble with mantel
Voltage	110-120V AC
Watts	1500W
Amps	10AMP Grounded Circuit

PRODUCT DIMENSIONS

MODEL NUMBER	A	B	C	D	E	F	G
CLASSIC 50	49-3/4" [1262mm]	17" [430mm]	5- 1/2" [140mm]	48- 7/16" [1230mm]	15- 5/8" [397mm]	12" [306mm]	46" [1168mm]
CLASSIC 60	59-3/4" [1516mm]	17" [430mm]	5- 1/2" [140mm]	58- 7/16" [1484mm]	15- 5/8" [397mm]	12" [306mm]	56" [1422mm]
CLASSIC 72	70 - 3/4" [1792mm]	17" [430mm]	5- 1/2" [140mm]		15- 3/4" [400mm]	12" [306mm]	

Installation and Assembly

Your appliance is a wall-mounted, recessed and/or mantel installed appliance. Select a suitable location that is not susceptible to moisture and is away from drapes, furniture and high traffic areas.

NOTE: Follow all National and local electrical codes.

MINIMUM CLEARANCE TO COMBUSTIBLES

Measurements are taken from the glass front.

Bottom	0"	Top	8" (300mm) to mantel
Sides	0"	Top	8" (300mm) to ceiling
Back	0"		

MINIMUM MANTEL CLEARANCES

WARNING

WHEN USING PAINT OR LACQUER TO FINISH THE MANTEL, THE PAINT OR LACQUER MUST BE HEAT RESISTANT TO PREVENT DISCOLOURATION.

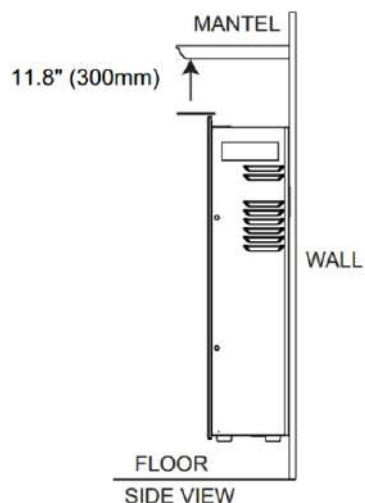

RECESSED TO WALL INSTALLATION

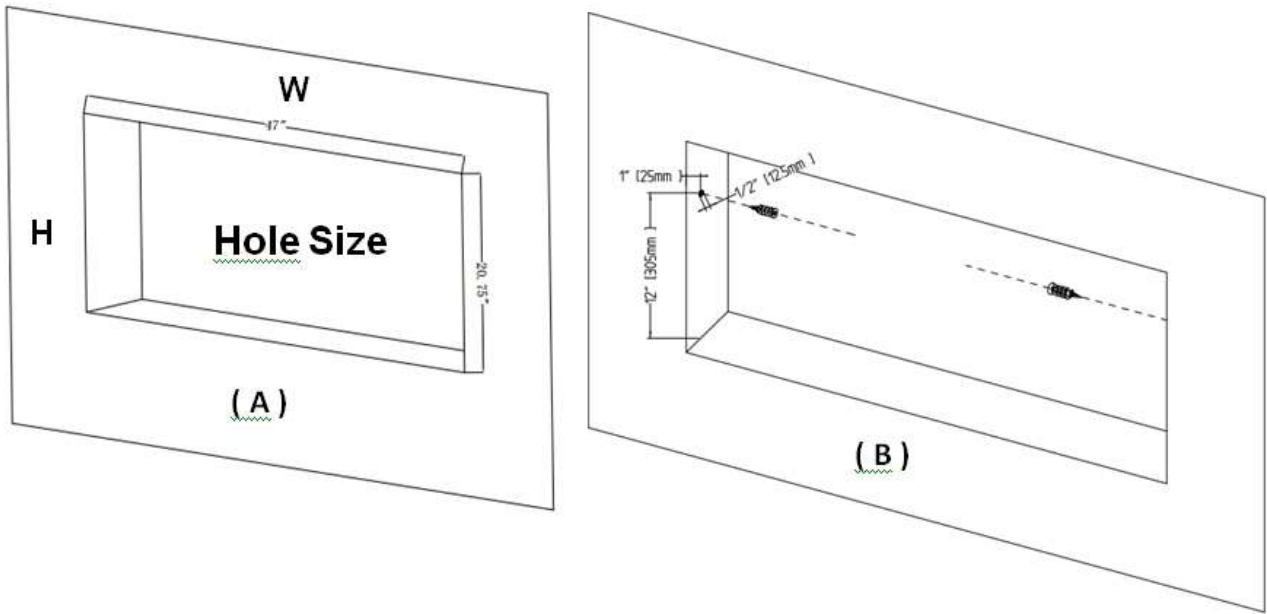

STEP A. Selection a dry wall to open a hole for fireplace box. Size of hole as below chart Figure (A)

FRAMING HOLE SIZE

Model Number	W	H
CLASSIC 50	48- 3/4" [1238mm]	15- 3/4" [400mm]
CLASSIC 60	58- 3/4" [1492mm]	15- 3/4" [400mm]
CLASSIC 72	70 - 3/4" [1792mm]	15- 3/4" [400mm]

STEP B. Fix the wall anchors in each side of the fireplace box according to the dimensions showed on the drawing. **Figure (B)**

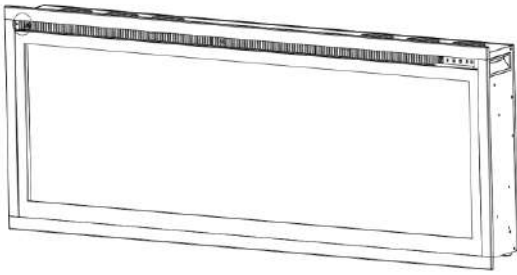

(C)

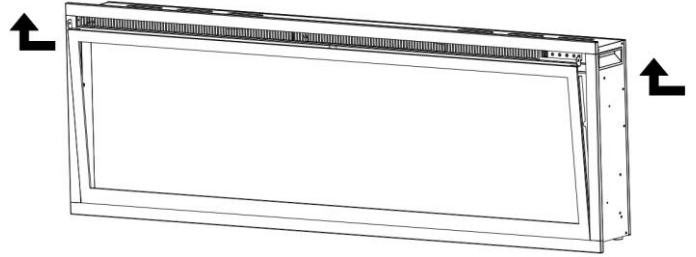

(D)

STEP C. Take off the screw in both sides of the glass panel. **Figure (C)**

STEP D. Have two person to take the glass panel out of the fireplace box. Place it to a soft and clean place. **Figure (D)**

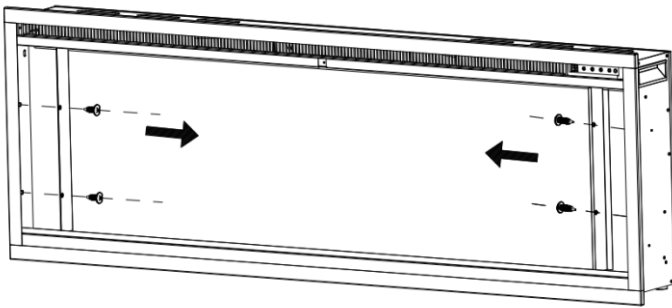

(E)

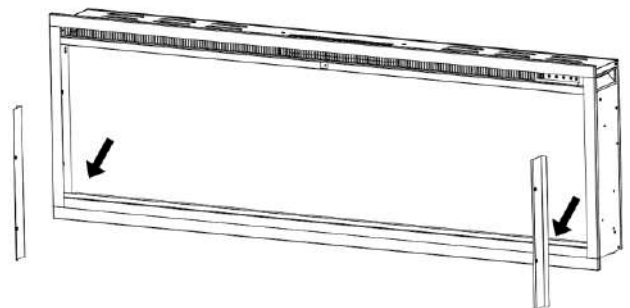

(F)

STEP E. Take off the two screws in both sides, then take off the two metal brackets, keep them well as you will need to screw back **Figure (E, F)**

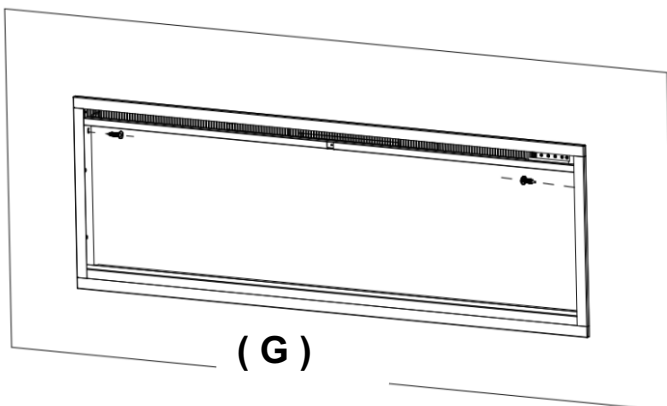

(G)

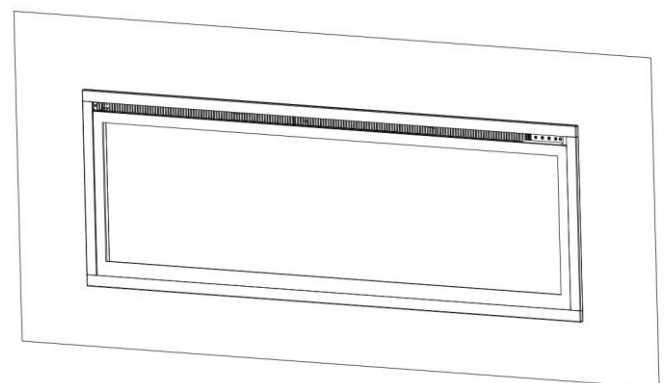

(H)

STEP F. Have two person to move the fireplace box to the wall hole. With the appliance is fully recessed into the wall.

- Use the 2 screws (provided) to lock the appliance into the wall with the existing two sides see **Figure (G)**
- Install the media and re-install the glass front. **Figure (H)**

Wall Mounted Installation

Due to the many different materials used on different walls, it is highly recommended that you consult your local builder before you install this appliance on the wall.

A. Select a location that is not prone to moisture and is located at least 36" (914mm) away from combustible materials such as curtain drapes, furniture, bedding, paper, etc.

B. Have two people hold the appliance against the wall to determine the final location.

C. Place unit face down on a soft, non abrasive surface. Remove the bracket from the back of the unit by removing the screws, refer to Figure 1.

D. Mark out location, then mount the bracket(s) onto the wall using the supplied screws. This bracket

MUST have the hooks facing upward and be level. **NOTE: It is strongly**

recommended that the mounting bracket (E) be Screwed into the wall studs Where possible. If the wall Studs cannot be used, ensure

That the supplied plastic anchors are used to affix the bracket to the wall and the bracket is adequately secured.

E. With the wall mounting bracket installed have two people lift the appliance up and insert the two hooks

on the bracket into the two slots on the back of the appliance.

F. Check the appliance for stability ensuring that the bracket will not pull free from the wall.

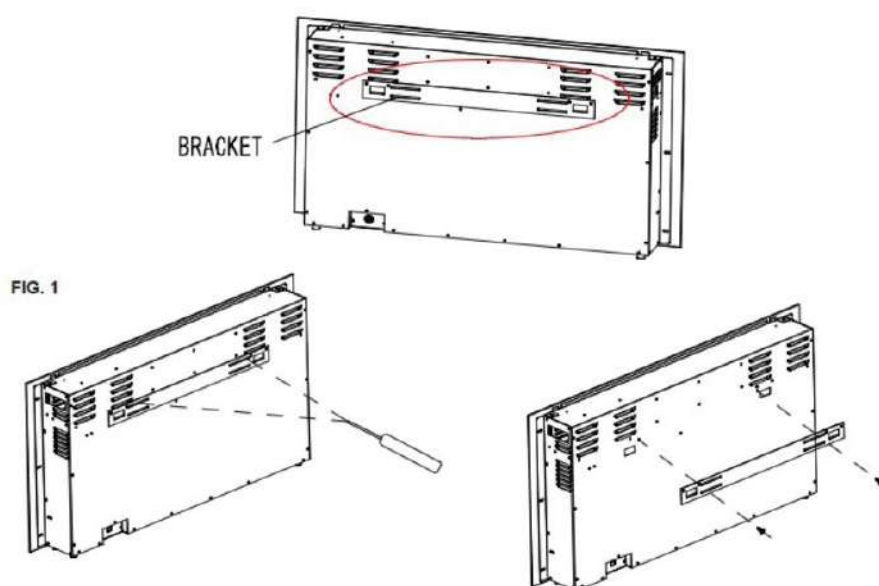
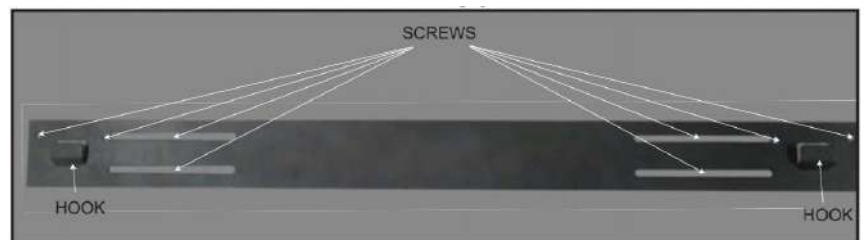

Drift Logs / Crystals / Pebbles Installation

(**NOTE:** Please make the installation according to the embers which you bought or selected.)

- A. Glass front must be removed and the appliance must be mounted in its final location before the drift logs embers are installed.
- B. Carefully place the small crystal embers or pebbles into the bottom tray on the front of the appliance as illustrated. Apply an even layer from side to side. **Figure 1, Figure 3.**
- C. Randomly place the large crystal embers on top of the small crystals embers. **Figure 2.**



Figure 1. (Small Crystals)



Figure 2. (Large Crystals)



Figure 3. (Pebbles medias)

Optional Drift wood logs installation

Carefully place birch wood logs on the surface of the small crystals media (see below illustration for recommended placement) (Figure 4.)



Figure 4. (Drift logs)

Operation



Read and understand this entire owner's manual, including **all safety information**, before plugging in or **using** this product. Failure to do so could result in **electric shock, fire, serious injury, or death.**

Power

Plug the power cord into a AC 110-120 Volt outlet (see **IMPORTANT SAFETY INFORMATION** on **Pages 2 and 3**). Make sure the outlet is in good condition and that the plug is not loose. **NEVER** exceed the maximum amperage for the circuit. **DO NOT** plug other appliances into the same circuit.

Methods of Operation



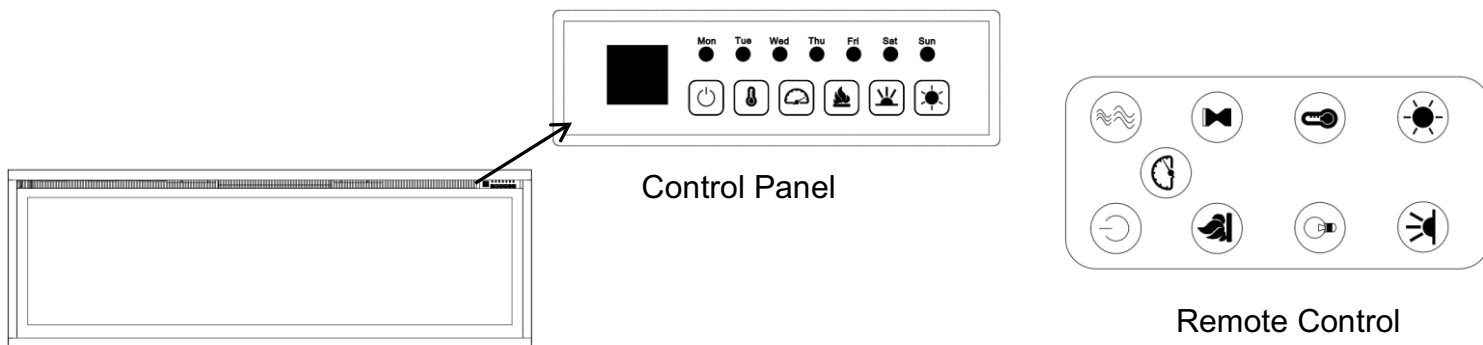

This electric fireplace can be operated by the CONTROL PANEL, or by the battery-powered REMOTE CONTROL.

Before operating, please review the **IMPORTANT SAFETY INFORMATION** on **Pages 2 and 3**, and heed all warnings.









Control Panel Operation

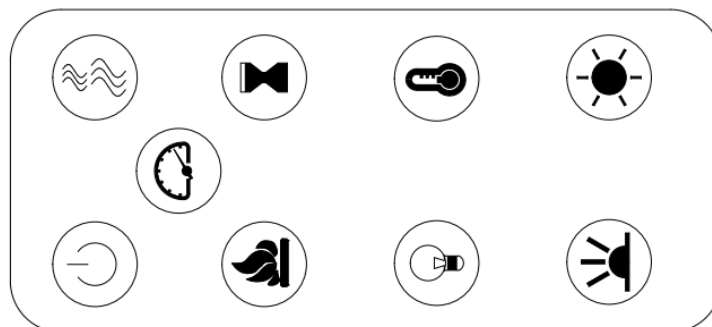

BUTTON	FUNCTION	ACTION & INDICATION																																																				
 POWER	<p>ON: Enables control panel functions and remote control. Turns on flame effect.</p> <p>OFF: Disables control panel functions and remote control. Turns off flame effect.</p>	<p>1. Press once. Indicator light turns on. Power turns on. All functions enabled.</p> <p>2. Press again. Flame effect turns off. Unit goes to standby. All functions turn off.</p>																																																				
 TEMP	<p>1. Press once: Touch panel indicator becomes active.</p> <p>2. Press again until desired setting is reached. Digital display shows setting circles as belows.</p> <table border="1" style="width: 100%; text-align: center;"> <tr> <td>NO</td> <td>0</td> <td>1</td> <td>2</td> <td>3</td> <td>4</td> <td>5</td> <td>6</td> <td>7</td> <td>8</td> <td>9</td> <td>10</td> <td>N</td> </tr> <tr> <td>°C</td> <td>20</td> <td>21</td> <td>22</td> <td>23</td> <td>24</td> <td>25</td> <td>26</td> <td>27</td> <td>28</td> <td>29</td> <td>30</td> <td>C</td> </tr> <tr> <td>°F</td> <td>68</td> <td>70</td> <td>72</td> <td>74</td> <td>76</td> <td>78</td> <td>80</td> <td>82</td> <td>84</td> <td>86</td> <td>88</td> <td>F</td> </tr> <tr> <td></td> <td>69</td> <td>71</td> <td>73</td> <td>75</td> <td>77</td> <td>79</td> <td>81</td> <td>83</td> <td>85</td> <td>87</td> <td></td> <td></td> </tr> </table>	NO	0	1	2	3	4	5	6	7	8	9	10	N	°C	20	21	22	23	24	25	26	27	28	29	30	C	°F	68	70	72	74	76	78	80	82	84	86	88	F		69	71	73	75	77	79	81	83	85	87			<p>NOTE: Press the button for 5 seconds to switch between ° C and ° F</p>
NO	0	1	2	3	4	5	6	7	8	9	10	N																																										
°C	20	21	22	23	24	25	26	27	28	29	30	C																																										
°F	68	70	72	74	76	78	80	82	84	86	88	F																																										
	69	71	73	75	77	79	81	83	85	87																																												

 <p>SPEED</p>	<p>Flame speed button: Controls the speed of the flame. There are 3 flame speed settings: 01 (slowest), 02 (Medium), 03 (fastest).</p>	<ol style="list-style-type: none"> Press once. Flame speed gets changing. Press again until desired setting is reached. Display shows the setting. <p>The Default setting is 02 (medium speed)</p>
 <p>FLAME COLOR</p>	<p>Flame color button: Makes the color flame effect changing.</p> <p>NOTE: color effect stays on until power button is turned off. Color flame effect must be on for heater to turn on.</p> <p>NOTE: this fireplace is with memory function for flame.</p>	<ol style="list-style-type: none"> Press once. Flame color effect gets changing. Press again until desired setting is reached. In total 6 colors for flame.
 <p>EMBER LIGHTS</p>	<p>LED Ember light button: Makes the color on bottom effect gets changing.</p> <p>NOTE: Ember color effect stays on until power button is turned off.</p> <p>NOTE: this fireplace is with memory function for LED ember lights.</p>	<ol style="list-style-type: none"> Press once. LED ember light color effect gets changing. Press again until desired setting is reached. In total 10 colors for EMBER. Auto-cycle function: When pressing with the 11th time, the LED ember light will do auto-cycling (NOTE: It will take 15 seconds to switch between colors.)
 <p>EMBER BRIGHTNESS</p>	<p>LED Ember light brightness button: Makes the LED ember lights on bottom effect gets changing.</p> <p>NOTE: LED Ember light brightness effect stays on until power button is turned off.</p>	<ol style="list-style-type: none"> Press once. LED ember light color effect gets changing. Press again until desired setting is reached. In total 5 levels. <p>From L1 - L2 - L3 - L4 - L5</p>

Remote Control Operation



BUTTON	FUNCTION	ACTION & INDICATION																																																				
 POWER	<p>ON: Enables control panel functions and remote control. Turns on flame effect.</p> <p>OFF: Disables control panel functions and remote control. Turns off flame effect.</p>	<ol style="list-style-type: none"> Press once. Indicator light turns on. Power turns on. All functions enabled. Press again. Flame effect turns off. Unit goes to standby. All functions turn off. 																																																				
 TEMP	<ol style="list-style-type: none"> Press once: Touch panel indicator becomes active. Press again until desired setting is reached. Digital display shows setting circles as belows. <table border="1" data-bbox="256 633 1506 801"> <thead> <tr> <th>NO</th> <th>0</th> <th>1</th> <th>2</th> <th>3</th> <th>4</th> <th>5</th> <th>6</th> <th>7</th> <th>8</th> <th>9</th> <th>10</th> <th>N</th> </tr> </thead> <tbody> <tr> <td>°C</td> <td>20</td> <td>21</td> <td>22</td> <td>23</td> <td>24</td> <td>25</td> <td>26</td> <td>27</td> <td>28</td> <td>29</td> <td>30</td> <td>C</td> </tr> <tr> <td>°F</td> <td>68</td> <td>70</td> <td>72</td> <td>74</td> <td>76</td> <td>78</td> <td>80</td> <td>82</td> <td>84</td> <td>86</td> <td>88</td> <td>F</td> </tr> <tr> <td></td> <td>69</td> <td>71</td> <td>73</td> <td>75</td> <td>77</td> <td>79</td> <td>81</td> <td>83</td> <td>85</td> <td>87</td> <td></td> <td></td> </tr> </tbody> </table> <p>NOTE: Press the button for 5 seconds to switch between ° C and ° F</p>	NO	0	1	2	3	4	5	6	7	8	9	10	N	°C	20	21	22	23	24	25	26	27	28	29	30	C	°F	68	70	72	74	76	78	80	82	84	86	88	F		69	71	73	75	77	79	81	83	85	87			
NO	0	1	2	3	4	5	6	7	8	9	10	N																																										
°C	20	21	22	23	24	25	26	27	28	29	30	C																																										
°F	68	70	72	74	76	78	80	82	84	86	88	F																																										
	69	71	73	75	77	79	81	83	85	87																																												
 HEATER	<p>HEATER button: Turns heater on and off.</p> <p>NOTE: The heater only works when the flame effect is on. If the flame effect is off, the heater will not turn on.</p> <p>NOTE: To prevent overheating, the heater blows cool air for 10 seconds before the heater turns on, and after it turns off.</p>	<ol style="list-style-type: none"> Press once. Indicator lights up. Fan blows cool air for 10 seconds. Low heater turns on and blows warm air. Press again. Indicator lights up. High heater turns on and blows hot air. Press again. Heaters turn off. The fan blows cool air, then turns off. 																																																				
 SPEED	<p>Flame speed button: Controls the speed of the flame. There are 3 flame speed settings: 01 (slowest), 02 (Medium), 03 (fastest).</p>	<ol style="list-style-type: none"> Press once. Flame speed gets changing. Press again until desired setting is reached. Display shows the setting. The Default setting is 02 (medium speed) 																																																				
 TIMER	<p>TIMER button: Controls timer settings to turn off fireplace at selected time. Settings range from 0.5 hours to 8 hours.</p>	<ol style="list-style-type: none"> Press once. Indicator light turns on. Timer is set to 0.5 hours. Press again until desired setting is reached. Indicator lights show setting. 																																																				
 FLAME COLOR	<p>Flame color button: Makes the color flame effect changing.</p> <p>NOTE: color effect stays on until power button is turned off. Color flame effect must be on for heater to turn on.</p> <p>NOTE: this fireplace is with memory function for flame.</p>	<ol style="list-style-type: none"> Press once. Flame color effect gets changing. Press again until desired setting is reached. In total 6 colors for flame. 																																																				

 FLAME BRIGHTNESS	<p>FLAME button: Makes flame effect dimmer and brighter.</p> <p>NOTE: Flame effect stays on until power button is turned off. Flame effect must be on for heater to turn on.</p>	<ol style="list-style-type: none"> Press once. Flame brightness effect gets changing. Press again. until desired setting is reached.
 EMBER LIGHTS	<p>LED Ember light button: Makes the color on bottom effect gets changing.</p> <p>NOTE: Ember color effect stays on until power button is turned off.</p> <p>NOTE: this fireplace is with memory function for LED ember lights.</p>	<ol style="list-style-type: none"> Press once. LED ember light color effect gets changing. Press again until desired setting is reached. In total 10 colors for flame. Auto-cycle function: When pressing with the 11th time, the LED ember light will do auto-cycling (NOTE: It will take 15 seconds to switch between colors.)
 EMBER BRIGHTNESS	<p>LED Ember light brightness button: Makes the LED ember lights on bottom effect gets changing.</p> <p>NOTE: LED Ember light brightness effect stays on until power button is turned off.</p>	<ol style="list-style-type: none"> Press once. LED ember light color effect gets changing. Press again until desired setting is reached. In total 5 levels. From L1 - L2 - L3 - L4 - L5

NOTICE When the heater is first turned on, a slight odor may be present. This is normal and should not occur again unless the heater is not used for a long period of time.

NOTICE To improve operation, **aim** the remote control at the front of the fireplace. **DO NOT press the buttons too quickly.** Give the unit time to respond to each command.

Temperature Limiting Control

This heater is equipped with a Temperature Limiting Control. Should the heater reach an unsafe temperature, the heater will automatically turn OFF. To reset:

1. Unplug the power cord from the outlet.
2. Turn the ON/OFF switch on the CONTROL PANEL to OFF. **Wait 5 minutes.**
3. Inspect the fireplace to make sure no vents are blocked, or clogged with dust or lint. If they are, use a vacuum to clean the vent areas.
4. With the POWER switch in the OFF position, plug the power cord back into the outlet.
5. If the problem continues, have your outlet and wiring inspected by a professional.

Remote Control Battery Information

- Remote control uses CR2025 batteries (**Included**)

NOTE: Remote control battery used depends on the remote control type which selected above.



NEVER dispose of batteries in **fire**. Failure to observe this precaution **may result in an explosion**. Dispose of batteries at your local hazardous material processing center.

Care and Maintenance

Cleaning



ALWAYS turn the heater **OFF** and **unplug the power cord from the outlet** before cleaning, performing maintenance, or moving this fireplace. Failure to do so could result in **electric shock, fire, or personal injury**.



NEVER immerse in water or **spray with water**. Doing so could result in **electric shock, fire, or personal injury**.

Metal:

- Buff using a soft cloth, slightly dampened with a citrus oil-based product.
- **DO NOT** use brass polish or household cleaners as these products will damage the metal trim.

Glass:

- Use a good quality glass cleaner sprayed onto the cloth or towel. Dry thoroughly with a paper towel or lint-free cloth.
- **NEVER** use abrasive cleansers, liquid sprays, or any cleaner that could scratch the surface.

Vents:

- Use a vacuum or duster to remove dust and dirt from the heater and vent areas.

Plastic:

- Wipe gently with a slightly damp cloth and a mild solution of dish soap and warm water.
- **NEVER** use abrasive cleansers, liquid sprays, or any cleaner that could scratch the surface.

Maintenance



Risk of electric shock! DO NOT OPEN any panels ! No user-serviceable parts inside!



ALWAYS turn the heater **OFF** and **unplug the power cord from the outlet** before cleaning, performing maintenance, or moving this fireplace. Failure to do so could result in **electric shock, fire, or personal injury**.

Electrical and Moving Parts:

- The fan motors are lubricated at the factory and will not require lubrication.
- Electrical components are integrated in the fireplace and are not serviceable by the consumer.

Storage:

- Store heater in a clean dry place when not in use.



WARNING! NO SERVICING of the internal or electrical parts should be performed by the consumer. Do not service the unit yourself.



WEEE:

Meaning of crossed –out wheeled dustbin:

Do not dispose of electrical appliances as unsorted municipal waste, use separate collection facilities. Contact you local government for information regarding the collection systems available. If electrical appliances are disposed of in landfills or dumps, hazardous substances can leak into the groundwater and get into the food chain, damaging your health and well-being.

When replacing old appliances with new ones, the retailer is legally obligated to take back your old appliance for disposals at least free of charge.

SUNTECK

www.sunteck.ca
info@sunteck.ca

